

DuroMax XP18HP / XP18HPE

General Purpose Gasoline Engine

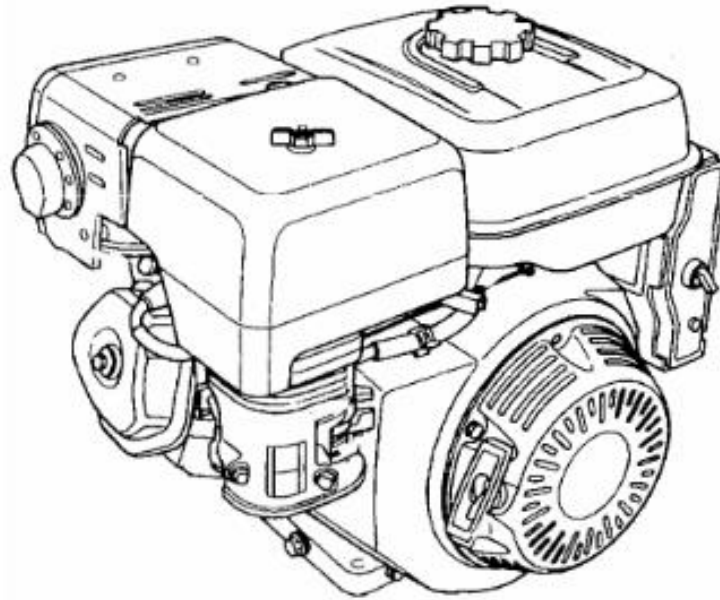

Owner's Manual

The manual gives information with respect to operation and maintenance of the general gasoline engine. Be sure to read it carefully first before operating. All the materials and diagrams of this manual are in accordance with the newest products at the publishing time. Due to revisions and other changes, the information described in this manual may be slightly different than the engine received. The copyright of this manual belongs to DuroMax Power Equipment, unauthorized reproduction is prohibited. Manual is subject to change without notice.



Please familiarize yourself with the following safety symbols and words:

The safety alert symbol is used with one of the safety words (DANGER, CAUTION, or WARNING) to alert you to hazards. Please pay attention to these hazard notices both in this manual and on the generator.

DANGER: Indicates a hazard that will result in serious injury or death if instructions are not followed.

WARNING: Indicates a strong possibility of causing serious injury or death if instructions are not followed.

CAUTION: Indicates a possibility of personal injury or equipment damage if instructions are not followed.

⚠ DANGER: This engine produces poisonous carbon monoxide gas when running. This gas is both odorless and colorless. Even if you do not see or smell gas, carbon monoxide may still be present. Breathing this poison can lead to headaches, dizziness, drowsiness, and eventually death.

- Use outdoors ONLY in non-confined areas.
- Keep several feet of clearance on all sides to allow proper ventilation of the engine.

⚠ WARNING: The exhaust from this product contains chemicals known to the State of California to cause cancer, birth defects, or other reproductive harm.

⚠ WARNING: This generator may emit highly flammable and explosive gasoline vapors, which can cause severe burns or even death. A nearby open flame can lead to explosion even if not directly in contact with gas.

- Do not operate near open flame.
- Do not smoke near generator.
- Always operate on a firm, level surface.
- Always turn generator off before refueling. Allow generator to cool for at least 2 minutes before removing fuel cap. Loosen cap slowly to relieve pressure in tank.
- Do not overfill gas tank. Gas may expand during operation. Do not fill to the top of the tank.
- Always check for spilled gas before operating.
- Empty the gasoline tank before storing or transporting the generator.

Before transporting, turn fuel valve to off and disconnect the spark plug.

CONTENTS

Safety Precautions	1
Parts Description	2
Control Connection of Remote Distance (optional)	3
Pre-Operate Inspection	4
Engine oil	4
Air cleaner	5
Fuel and fuel tank	6
Starting of the Engine	8
Operation	10
Stop	12
Exhaust Control System	13
Maintenance.....	13
Replacement of parts.....	13
Modifying.....	14

Maintenance	15
Maintenance Schedule	15
Maintenance Procedures	17
Transport, Storage and Removal from Storage	23
Transport	23
Storage	23
Removal from storage.....	24
Troubleshooting.....	25
Will not start	25
Low Power	27
Running Rough	28
Engine Stalls	29
Running Hot	31
Excess or Abnormal Noise.....	32
Specifications.....	33
Main specifications.....	33
Timing of distribution.....	34
Torque of important bolts.....	34
Electric Diagram.....	35

SAFETY PRECAUTIONS

WARNING

Before operating the engine, be sure to read and become familiar with the manual, otherwise injury to personnel or damage to equipment may occur.

Please pay special attention to the following:

1. Run the engine in a well-ventilated place, keep it at least one meter away from building walls or other equipment, and keep away from inflammables such as gasoline, matches and so on to avoid the possibility of fire.
2. Keep the engine out of reach of children and pets to avoid accidents.
3. Be sure the operator of the engine has been specially trained.
4. Refuel in a well-ventilated area with the engine stopped, and in places refueling or storing gasoline, no smoking, flames, or sparks.
5. When refueling, leave at least 1 inch of free space at the top of the tank to avoid spills and vapor lock. If there is spilled fuel around, be sure to clean it thoroughly before starting.
6. Place the engine on a level-working platform to avoid fuel spilling out.
7. Make sure the fuel cap is tightened securely.
8. The exhaust muffler is very hot during running the engine even after the engine stops. Never touch it, or you may get burns. Transport or store the engine with it cooled down entirely.

PARTS DESCRIPTION

The main parts of engine are located as follows (Fig.1):

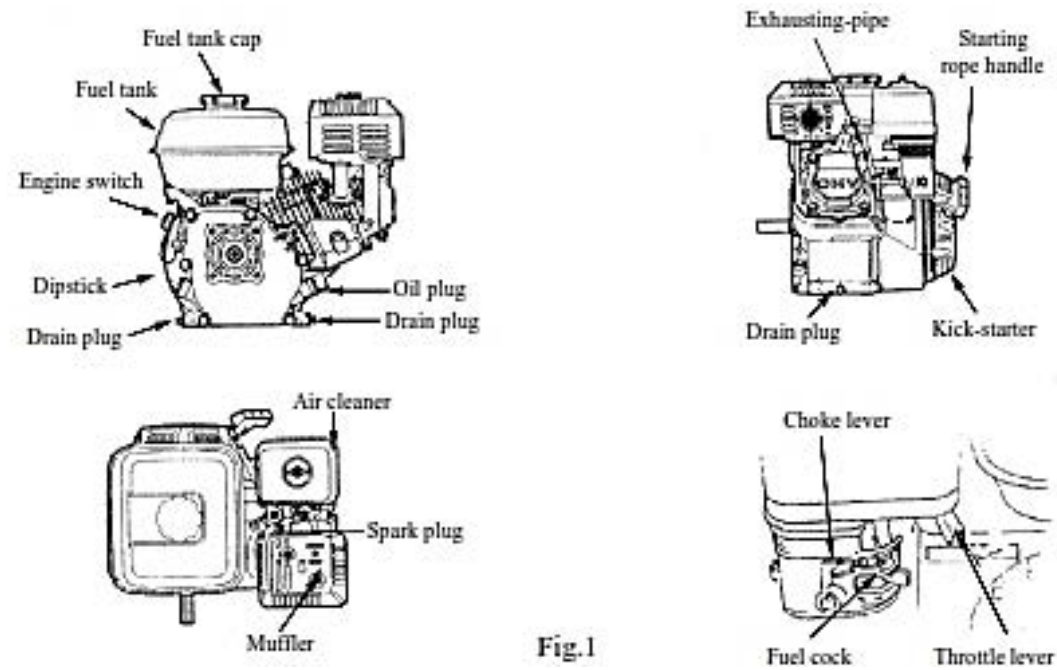

Fig.1

CONTROL CONNECTION OF REMOTE DISTANCE (OPTION)

The holes in levers of both the choke and throttle valve are used for mounting optioned steel wires. Illustrations show how to mount a solid steel wire and a meshed steel wire. If choosing a meshed steel wire a return spring is added.

If necessary, you may unscrew the damping nut on the throttle valve lever slightly when controlling the throttle valve by a remote-controlled steel wire.

Accessory Options:

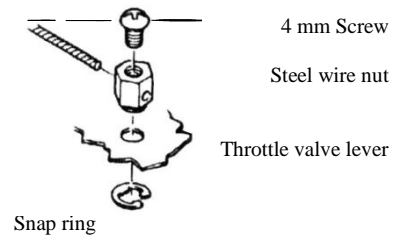
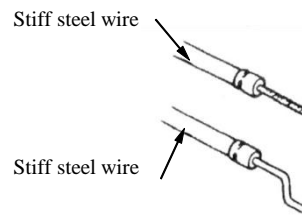

Remote-Controlled Throttle:

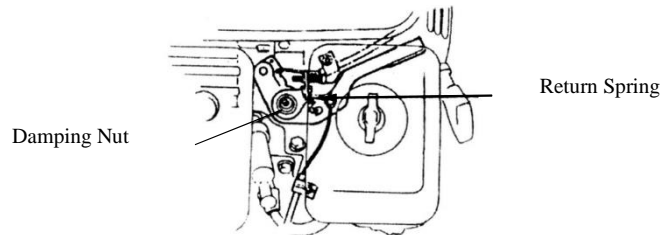

Remote-Controlled Choke:

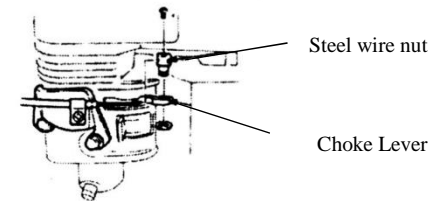

Pre-Operation Inspection

Engine Oil

Caution

- Engine oil is a key factor in deciding the engine's performance. Do not apply engine oil with additives or 2-stroke gasoline oil, as they haven't enough lubrication, which may shorten the engine's service life.
- Check the engine with it stopped on a level ground.

Engine oil recommended: SAE10W-30

As viscosity varies with regions and temperatures, so the lubricant has to be selected in accordance with our recommendation.

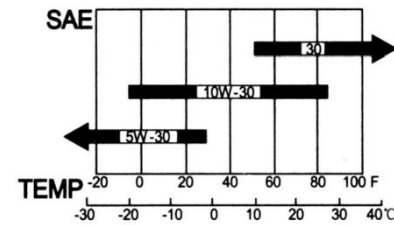

Check

1. Ensure that the engine is stopped on a level ground.
2. Remove the dipstick and clean it.
3. Reinsert the dipstick into the oil filler without screwing in, and check oil level.
4. If the oil level is too low, add recommended engine oil to the filler neck.
5. Reinstall the dipstick.

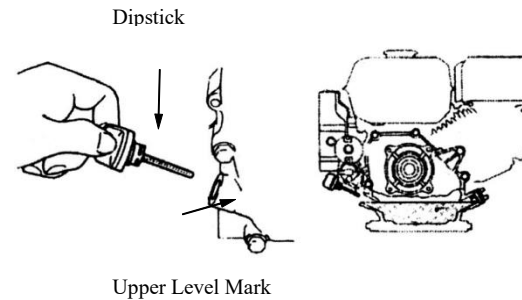

AIR CLEANER

Dismantle the air cleaner housing and check its filter element, make sure it is clean and intact, if not or replace it.

CAUTION

Never run the engine without an air cleaner, or severe wear of the engine may occur.

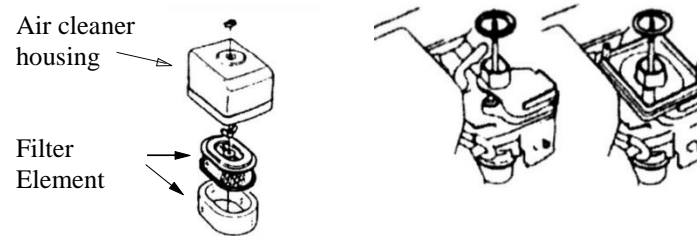

FUEL AND FUEL TANK

1. Fuel

The engine must use unleaded gasoline with an octane number over 86. Using unleaded gasoline will decrease the possibility of producing carbon deposits and prolong the engine's service life. Never apply used or polluted gasoline or a mixture of gasoline and engine oil. Make sure the fuel is free of dirt and water.

2. Gasoline Containing Alcohol

If you decide to use a gasoline containing alcohol (fuel blend), be sure its octane rating is at least as high as that recommended. Use gasoline containing less than 10% ethanol or 5% methanol content in the fuel blend exceeds 5%, it may have an effect on engine performance, and may damage metal, rubber and plastic parts.

CAUTION

- Handle fuel with care, it can damage plastic and painted surfaces.
- It is normal to hear an occasional light spark knock or pinging with the engine running under heavy load.
- Should spark knock or pinging be heard at a steady speed under normal load, change the brand of gasoline; if it continues, consult your dealer for help, the engine may be damaged.

3. Fuel Tank

Fuel tank capacity: 3.6 liters

4. Check

- Remove the fuel filler Cap and check fuel level.
- If the fuel level is too low, refuel the tank. Remember adding fuel not over the fuel filter shoulder

Upper Fuel Level

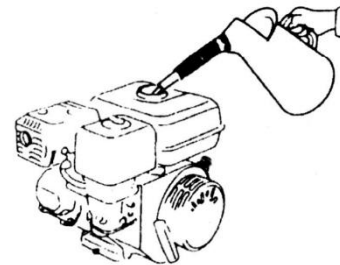
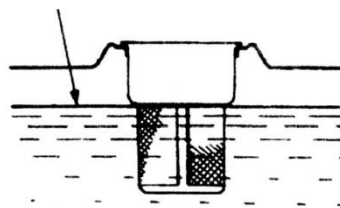

⚠ WARNING

- Gasoline is extremely flammable and is explosive under certain conditions. Refueling in a well ventilated area with the engine stopped. Do not smoke and allow flames or sparks in the area where gasoline is stored or where the fuel tank is refueled.
- Do not overfill the tank (there should be no fuel in the filler neck). After refueling, make sure the fuel tank cap is set back securely.
- Be careful not to spill fuel when refueling. Spilled fuel or fuel vapor may ignite. If any fuel is spilled, make sure the area is dry enough before starting the engine.
- Avoid repeated or prolonged contact with skin or breathing of fuel vapor.
- Keep out of reach of children.

STARTING OF THE ENGINE

1. Push the fuel cock to “ON.”

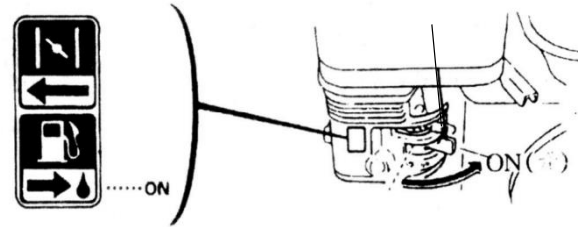

2. Push the choke lever to “CLOSE.”

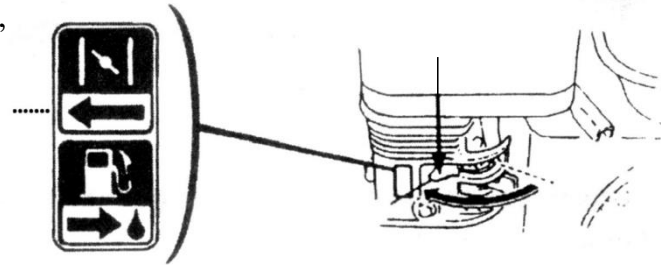

NOTE

If the engine is hot, closing the choke is unnecessary.

3. Move left the throttle lever a little.
4. Start the engine (Fig. 16).
 - a) Push the engine switch to “On”
 - b) Pull slightly the starting rope handle up until feeling anti-action, and then make a rapid pull.

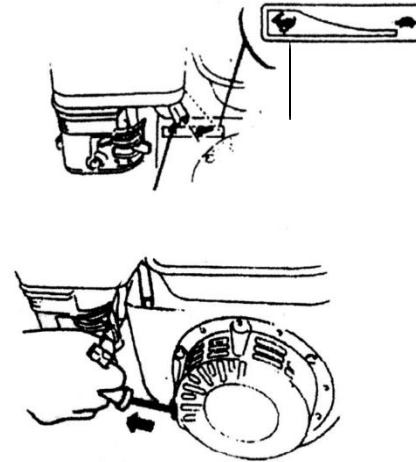
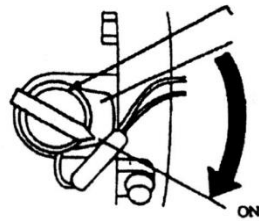

CAUTION

Releasing the handle suddenly may make it hitting the engine. Release the handle slowly conforming to its recoiling force.

OPERATION

1. Preheat the engine and push back the choke lever to “OPEN”

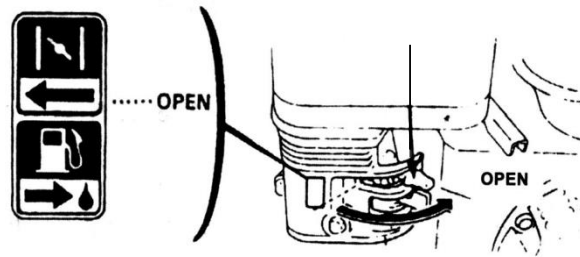

2. Set the throttle lever in proper position to ensure the engine runs at required velocity

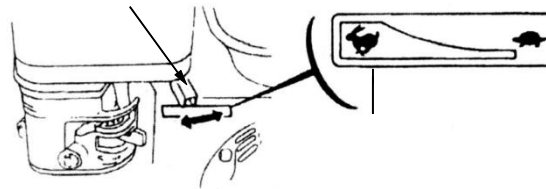

Engine Oil Alarm

The engine oil alarm is designed to alarm the user the fact that the engine oil in the crankcase is insufficient. Running with insufficient engine oil may damage the engine. When the oil level in the crankcase is too low, the engine oil alarm will stall the engine automatically while the engine switch is still at “ON”.

CAUTION

If the engine still fails to work, check the engine oil level first before go to other check items.

Operating at high altitude

On highlands, the standard mixture ratio too rich and the engine performance may be impaired while the fuel consumption may increase. This can be solved by replacing the main jet of carburetor and adjusting the idle screw. If always at high altitude, ask your dealer to install the jet after purchase. The engine power will decrease by about 3.5% with every 500 ft. in height; even the proper main jet is used.

CAUTION

The engine equipped with the high alt main jet may be damaged seriously if run at sea level due to its mixture ratio being too thin. Have your dealer reinstall the sea level jet before running at sea level.

STOP

In an emergency, push the engine switch to “OFF” to stall the engine.

During normal operation, stop the engine in the following sequence:

1. Push the throttle valve lever to the right.
2. Push the engine switch to “OFF”
3. Turn the fuel lever to “OFF”

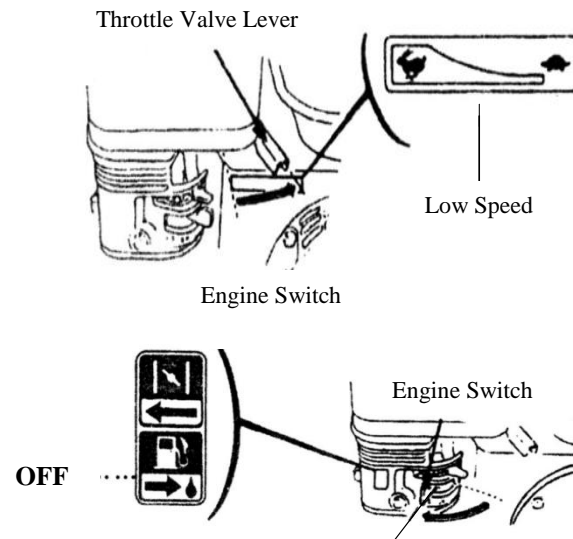
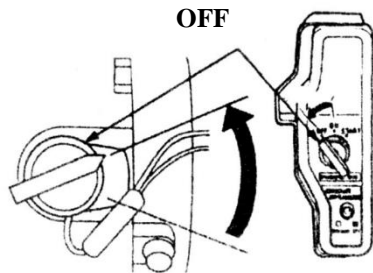

EXHAUST CONTROL SYSTEM

With the engine running, carbon monoxide, nitrogen oxide, and hydrocarbons will be produced, and in certain conditions, nitrogen oxide and hydrocarbons will react chemically with each other to make smoke. Exhaust control is very important, carbon monoxide is toxic. DuroMax Power Equipment decreases exhaust emissions by using lean carburetors and other devices in the engine design.

To keep the exhaust of your engine within the standard exhaust emission values, pay attention to the following:

I. MAINTENANCE

Maintain the engine in accordance with the Maintenance Schedule in the manual. The maintenance schedule is based on normal use in normal conditions, if using under heavy load, dusty or wet areas, or in high temperatures, more frequent maintenance will be necessary.

II. REPLACEMENT OF PARTS

We recommend that you use DuroMax Power Equipment OEM parts. Using aftermarket parts may impair the exhaust control system effectiveness.

III. MODIFICATION

Modifying the exhaust control system may cause exhaust emissions to exceed statutory limit values. Illegal modifications are as follows:

1. Dismantling or modifying any part of air inlet or outlet system.
2. Modify or remove speed-adjusting connection device or speed adjustment device to result in the engine running outside the set parameters.

IV. PROBLEMS RELATED TO EXHAUST EMISSIONS

1. Difficultly starting or stopping the engine.
2. Unstable idle.
3. Black smoke and fuel consumption increase..
4. Poor ignition spark or backfiring.
5. Early or late ignition spark.

MAINTENANCE

I. MAINTENANCE SCHEDULE

To keep the engine in a sound condition, the user should maintain it according to the table below:

		Every Use	1 st Use and/or 20 hrs.	3 months and/or 50 hrs.	6 months and/or 100 hrs.	Yearly and/or 300 hrs.
Engine oil	Oil level check	√				
	Replace		√		√	
Reduction gear oil (optional)	Oil level check	√				
	Replace		√		√	
Air cleaner	Check	√				
	Clean			√(1)	√(1) *	
	Replace					√ **
Deposit cup	Clean				√	
Spark plug	Clean/adjust				√	
	Replace					√
Spark Arrestor	Clean				√	
Idling	Check-adjust					√(2)
Valve Clearance	Check-adjust					√(2)
Fuel tank & filter	Clean					√(2)
Fuel Line	Clean	Every two years (do replacement if necessary)				

CAUTION

We recommend that you use DuroMax Power Equipment OEM parts. Using aftermarket parts may damage the engine and will void the Manufacturer's Warranty.

NOTES

* : Only for inside-ventilating double-core carburetors.

** : Only for paper core air cleaners.

① More often than that in the schedule if in dusty circumstances.

② These items should be done by your dealer unless you are specially trained and are well equipped with tools.

⚠ WARNING

Stop the engine before servicing. If service is required with the engine running, be sure to keep good ventilation in the area. The exhaust emissions from the engine contain toxic carbon monoxide, inhaling this toxic gas may do harm to personnel and even result in death.

II. MAINTENANCE PROCEDURES

1. Changing the Oil

A warm engine is helpful to drain out the engine oil in the crankcase quickly and completely.

- a) Remove the oil fill cap and drain plug to drain the engine oil thoroughly.
Reinstall the drain plug securely
- b) Fill the specified engine oil to the upper level mark.
- c) Reinstall the oil fill cap.

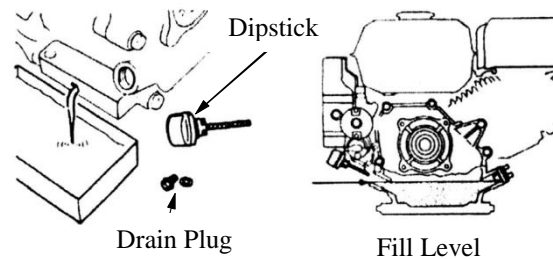

Engine oil capacity: 37 fl. oz. (1.1L)

NOTE

Do not dispose of oil containers or dirty engine oil into trash containers, onto the ground, or down the drain. Store dirty engine oil in a closed container and bring to a local oil recycling station for disposal.

2. Air Cleaner Maintenance

A dirty air cleaner may block proper airflow into the carburetor. Service the air cleaner regularly to keep the engine running in peak condition. If operating the engine in an extremely dusty area, the air cleaner should be serviced more often.

⚠ WARNING

Never clean the air cleaner in gasoline or low flash-point detergents, explosion may occur.

CAUTION

Never run the engine without an air cleaner, or air with dirt and dust may enter the engine and cause engine wear.

Unscrew the wing nut and dismantle the air cleaner housing. Check the two cores for damage. If any, replace with new one.

- a) Foam filter element: clean with mild detergent and warm water (or non-flammable of high flash-point cleaning solvents) and dry, then soak in clean engine oil until saturated. Squeeze out excess oil before installing.
- b) Paper filter element: knock the core against a solid plane to get rid of accumulated dust or blow out dust from inside to outside with high-pressure airflow (not more than 30 psi). Never clean with a brush, as brushing may force the dust into the core fiber. If the core is extremely filthy, replace it with a new one.

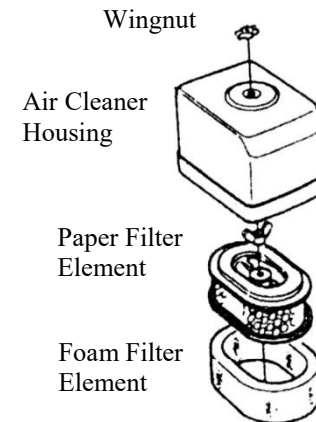

3. Cleaning the Fuel Cup

Set the fuel valve to “OFF”, remove the fuel cup and O-ring. Wash them in non-flammable or high flash-point cleansing solvents, dry them, and reinstall. Set the fuel switch to “ON” and check for leaks.

⚠ WARNING

- Gasoline is extremely flammable and explosive in certain conditions. Keep cigarettes, sparks, and open flames away.
- After reinstalling the fuel cup, check it for leaks and check the area around the engine for spilled fuel.

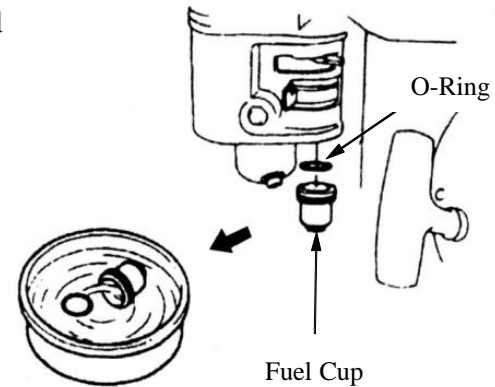

4. Spark Plug

Spark plug type: BP6ES, BPR6ES (NGK) or NHSPLD F6RTCUC

Proper spark plug clearance will avoid spark plug deposits and wear.

- a) Remove the spark plug using the included spark plug wrench.
- b) Clean the spark plug with a steel brush. If the insulator is damaged, replace the spark plug.
- c) Measure the spark plug clearance with a feeler. The clearance should be 0.7-0.8mm. If adjustment is necessary, bend the side electrode carefully.
- d) Check that spark plug gasket is in good condition, or replace with a new one. Install the spark plug first by hand and then tighten it using a spark plug wrench. If a new spark plug is used, twist $\frac{1}{2}$ turn after impacting the gasket; if reinstall the original one, just twist $\frac{1}{8}$ - $\frac{1}{4}$ turn more.

⚠ WARNING
Be careful not to touch the muffler during or just after running the engine.

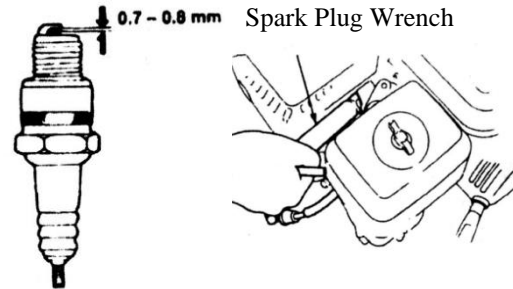

CAUTION

- The spark plug must be tightened securely, or it may become very hot and damage the engine.
- Only use listed spark plug or equiv. Incorrect spark plug heat range may damage the engine.

5. Spark Arrestor

The spark arrestor should be serviced at least once every 100 hours of operation.

- a) Unscrew two nuts M4, and remove the exhaust elbow from the engine body.
- b) Remove the (5) M5 screws from the muffler guard and remove the guard.
- c) Remove the M4 screw from the spark arrestor and separate it from the muffler.
- d) Clean any carbon buildup from the spark arrestor with a wire brush.
- e) Reinstall the spark arrestor in reverse order of removal.

⚠ WARNING
Be careful not to touch the muffler during or just after running the engine.

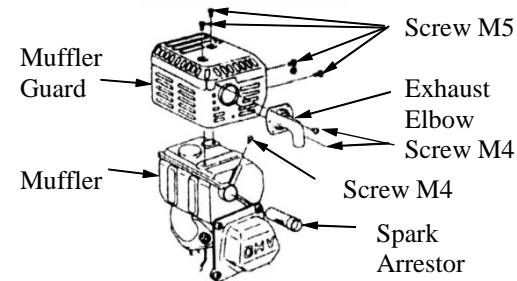

CAUTION

- Be careful not to damage the mesh of the spark arrestor.
- Never use a damaged spark arrestor.

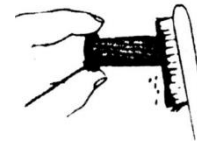

6. Carburetor Idle Adjustment

- a) Start and warm up the engine to a normal running temperature.
- b) Set the idle speed by adjusting the throttle adjustment screw on the carburetor until the engine runs smoothly at the lowest speed possible.

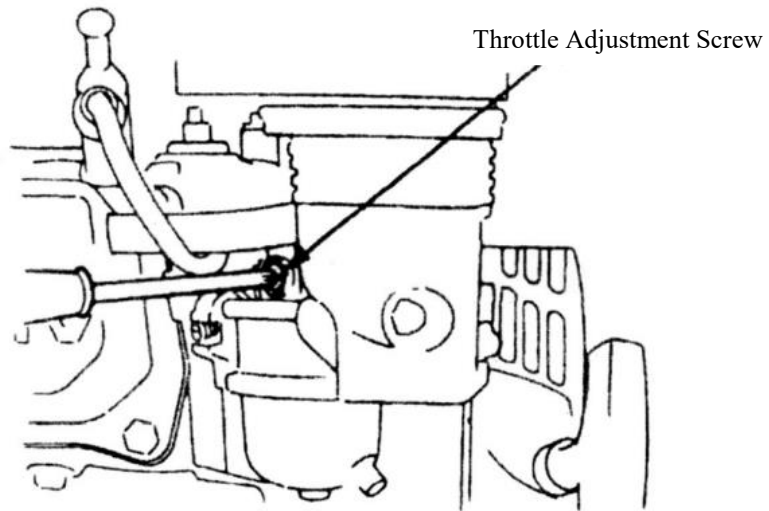

Standard idle: 1700 ± 15 rpm

TRANSPORT, STORAGE, AND REMOVAL FROM STORAGE

I. TRANSPORT

Transport with the fuel valve turned off. Always let the engine cool completely before transporting.

II. STORAGE

If the engine is stored for an extended period, be sure to store it properly.

CAUTION

To avoid fuel spins do not lean the engine when filling. Spilled fuel or fuel vapor may ignite and cause fire.

1. Drain the Gasoline from the carburetor and fuel valve.
2. Remove the spark plug. Pour 1 tbsp. of fresh engine oil through the spark plug hole into the cylinder. Pull the recoil rope to rotate the engine and distribute engine oil evenly, and re-install the spark plug.
3. Pull the starting rope slowly until you feel a slight resistance. Align the arrow of the pulley cup with the hole in the starter.
4. Store the engine covered in a clean dry garage or shed..

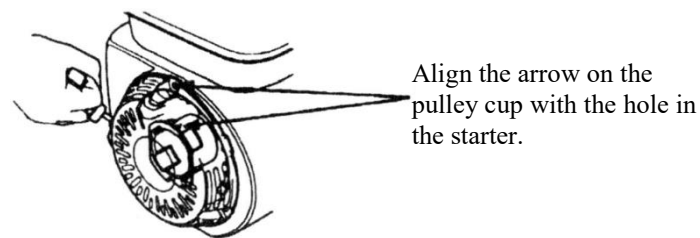
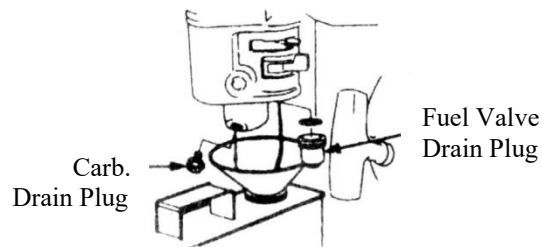

III. REMOVAL FROM STORAGE

After storage perform maintenance according to the following:

Storage time	Service item
Under 1 Month	No additional maintenance is required
1 - 2 Months	Completely drain and replace gasoline.
2 Months – 1 Year	Completely drain and replace gasoline. Clean carburetor and fuel lines thoroughly.
1 Year or More	Completely drain and replace gasoline. Clean carburetor and fuel lines thoroughly. Inspect cylinder and spark plug.

⚠ WARNING

Fuel is extremely flammable and explosive under certain conditions. Keep cigarettes, open flames, and sparks away from the operating site.

Troubleshooting Guide

I. Will not start - Troubleshooting

ISSUE	PROBLEM	SOLUTION
1. Fuel Low	There is not enough fuel in the fuel tank or fuel valve is closed.	Fill fuel tank, open fuel valve.
2. Low Fuel Flow ▲ Good Compression ▲ Good Spark	Air vent valve in the fuel tank is clogged.	Clear the air vent valve.
	Fuel valve is clogged.	Clean the fuel valve.
	Improper or clogged main jet.	Readjust or clean the main jet.
	Needle valve is closed improperly or fuel hole is clogged.	Dismantle needle valve and repair, clean, or replace.
	Float is damaged or sticking.	Repair float.
3. Fuel System Issue ▲ Good Compression ▲ Good Spark ▲ Good Fuel Flow	Fuel is dirty or deteriorated.	Replace fuel.
	There is water in fuel.	Replace fuel.
	Too much fuel in engine cylinder.	Drain excess fuel, dry spark plug electrode.
	Wrong fuel type.	Select a proper fuel within requirements.

ISSUE	PROBLEM	SOLUTION
4. Fouled Spark Plug ▲ Good Compression ▲ Good Fuel Supply ▲ Good Ignition Coil	Carbon and/or dirt around electrodes.	Clean Spark Plug.
	Electrode is burned, damaged seriously, or insulators damaged.	Replace spark plug.
	Improper spark plug gap.	Adjust to proper value.
5. No Spark ▲ Good Compression ▲ Good Fuel Supply ▲ Good Spark Plug	Spark plug cap is damaged.	Replace ignition coil.
	Ignition coil damaged.	Replace ignition coil.
	Magneto loses magnetism.	Replace ignition coil.
6. Low Compression ▲ Good Fuel Supply ▲ Good Ignition System	Piston rings are overly worn.	Replace piston rings.
	Piston rings are sticking.	Clean carbon from cylinder.
	Piston rings are broken.	Replace piston rings.
	Spark plug is loose or missing the gasket.	Replace spark plug gasket and retighten.
	Air leaking from below the cylinder head.	Check cylinder head for warping, replace gasket, and torque to listed specifications.

⚠ WARNING

- When testing the spark plug, never hold the high-voltage wire with wet hands.
- Fuel vapor is flammable, keep away from sparks and open flame.

II. Low Power - Troubleshooting

ISSUE	PROBLEM		SOLUTION
Throttle speed increase responds slowly, speed drops, or engine stalls	Ignition system	Incorrect ignition timing	Readjust ignition advance angle
	Fuel Supply System	Air in fuel line or fuel line clogged.	Bleed air from and clean the fuel line.
		Main jet is not adjusted properly.	Readjust the main jet.
		In carburetor, needle valve or main jet clogged.	Clean carburetor jets and ports.
		Fuel valve is clogged.	Clean or replace fuel valve.
		Cylinder has carbon buildup.	Clean carbon from the cylinder.
		Air Cleaner is dirty or clogged.	Clean filter element.
		Fuel line is leaking.	Replace the fuel line.

ISSUE	PROBLEM	SOLUTION	
Throttle speed increase responds slowly, speed drops, or engine stalls	Low Compression	Piston, cylinder, or piston rings are worn.	Replace worn parts.
		Air leaking from below the cylinder head.	Check cylinder head for warping, replace gasket, and torque to listed specifications.
		Valve clearance is incorrect.	Adjust the valve clearance.
		Loose or misaligned valve(s)	Repair and/or adjust valve seat and/or spring.

III. Running Rough - Troubleshooting

ISSUE	PROBLEM	SOLUTION
Engine is pinging	Piston, cylinder, or piston rings are worn.	Replace worn parts.
	Piston pin and/or piston pin channel are worn.	Replace piston and/or piston pin
	Connecting rod is worn.	Replace connecting rod.
	Crankshaft bearing is worn.	Replace crankshaft bearing.

ISSUE	PROBLEM	SOLUTION
Abnormal combustion	Engine is overheating.	Troubleshoot heat issue (See Troubleshooting Section V).
	Cylinder has carbon buildup.	Clean carbon from the cylinder.
	Wrong fuel type.	Select a proper fuel within requirements.
Low or No Spark	There is water in float bowl.	Clean float bowl.
	Improper spark plug gap.	Adjust to proper value.
	Incorrect ignition timing	Readjust ignition advance angle
	Ignition coil damaged.	Replace ignition coil.

IV. Engine Stalls - Troubleshooting.

ISSUE	PROBLEM		SOLUTION
Engine Stalls when running.	Fuel System	Fuel is empty	Fill Fuel.
		Carburetor is clogged.	Clean carburetor and fuel line.
		Float Bowl is leaking.	Repair float bowl or replace carburetor.
		Need valve sticks.	Repair need valve or replace carburetor.

ISSUE	PROBLEM		SOLUTION
Engine Stalls when running.	Ignition system	Spark plug is damaged or dirty.	Replace the spark plug.
		Spark plug electrode is damaged.	Replace the spark plug and remove any debris from the engine.
		Spark plug cap is loose or damaged.	Inspect and replace or connect spark plug cap.
		Engine oil is low.	Add engine oil to the upper level mark.
		Spark plug wire is damaged or broken.	Replace ignition coil complete.
		Stop switch wire is shorted to the engine block.	Inspect stop switch wire and repair or replace.
	Other	Valve guide(s) is damaged or worn.	Repair or replace valve guide(s).

V. Running Hot - Troubleshooting

TROUBLE	CAUSE	REMEDY
Engine is excessively hot	Incorrect ignition timing	Readjust ignition advance angle
	Engine oil is low.	Add engine oil to the upper level mark.
	Exhaust pipe is clogged	Clean the exhaust pipe.
	Exhaust leak at muffler or cylinder head.	Repair exhaust leak.
	Flywheel fan is dirty or clogged with debris.	Clean the flywheel fan.
	Flywheel fan is loose.	Tighten the flywheel fan bolts.
	Piston, cylinder, or piston rings are worn.	Replace worn parts.
	Connecting rod is worn.	Replace connecting rod.
	Engine speed is set too fast.	Adjust engine speed to proper value.
	Crankshaft bearing is worn.	Replace crankshaft bearing.

NOTE: The engine should measure: 176°F (80°C) - 212° F (100°C) at the exhaust outlet and < 140° on the lower side of the crankcase. If temperatures exceed these specifications the engine is running excessively hot.

VI. Excess or Abnormal Noise

TROUBLE	CAUSE	REMEDY
Piston slap or banging sound is heard.	Piston, cylinder, or piston rings are worn.	Replace worn parts.
	Piston pin and/or piston pin channel are worn.	Replace piston and/or piston pin
	Connecting rod is worn.	Replace connecting rod.
	Crankshaft bearing is worn.	Replace crankshaft bearing.
Timing "off" or beating sound is heard.	Cylinder has carbon buildup.	Clean carbon from the cylinder.
	Improper spark plug gap.	Adjust to proper value.
	Engine is flooded with fuel.	Need valve sticks, Repair needle valve or replace carburetor.
	Wrong fuel type.	Select a proper fuel within requirements.
	Engine is overheating.	Troubleshoot heat issue (See Troubleshooting Section V).
	Valve clearance is incorrect.	Adjust the valve clearance.
	Flywheel is loose.	Tighten the flywheel connection to the crankshaft.

SPECIFICATIONS

DuroMax XP18HP XP18HPE Engine			
Inclined overhead (OHV 25°), Single Cylinder, Forced Air Cooled, 4-Stroke Gasoline Engine			
Engine Type	192F	Displacement	440 cc
Rated Power (KW/rpm)	9.0 kW (18.0 HP) @ 3600 rpm	Compress ratio	8.5 : 1
Max Torque	19.55 ft. lb. @ 2500 rpm	Lubrication mode	Splash
fuel consumption	≤370 g/KWh	Oil specification	15W/40SAE
Oil consumption	≤6.8 g/KWh	Fuel specification	≥87 octane, ≤10% ethanol, unleaded gasoline
Lowest idling speed	1600 ± 100 r/min	Spark plug clearance	0.023 in. (0.6 - 0.8mm)
Noise Level	≤104 dBA	Ignition System	TCI
Cylinder diameter	92 mm	Dimensions (LxWxH)	16.14"x17.91"x17.44"
Piston Stroke	66 mm	Weight	74.96 lb. (34 kg)

Adjustment Specifications

Part	Specification
Carburetor idling	1700 ± 150 rpm
Valve clearance (cold)	Intake: .006 in ± .001 in. (0.15mm ± 0.02mm) Exhaust: .008 in ± .001 in. (0.20mm ± 0.02mm)
Spark plug type	BPR6ES (NGK) RN9YC (Champion) WR7DC (Bosch) W20EPR-U (Denso)
Spare plug clearance	.027-.031 in. (0.7-0.8 mm)

Timing Distribution

Intake Open	BTDC 10°
Intake Closed	ABCD 20°
Exhaust Open	BBDC 30°
Exhaust Closed	ATDC 10°

Engine Specifications

Item	Specification
Model	192F
Ignition system	Non-transistorized ignition (TCI)
Shaft Rotation	Counterclockwise

Bolt Torque Value

Bolt	Torque Value
Cylinder head bolt	18 ft. lb. (24 NM)
Flywheel bolt	50 - 60 ft. lb. (70-80 NM)
Crankcase bolt	18 ft. lb. (24 NM)
Tie-rod bolt	9 ft. lb. (12 NM)

ELECTRIC DIAGRAM

Bl	Black
Y	Yellow
G	Green

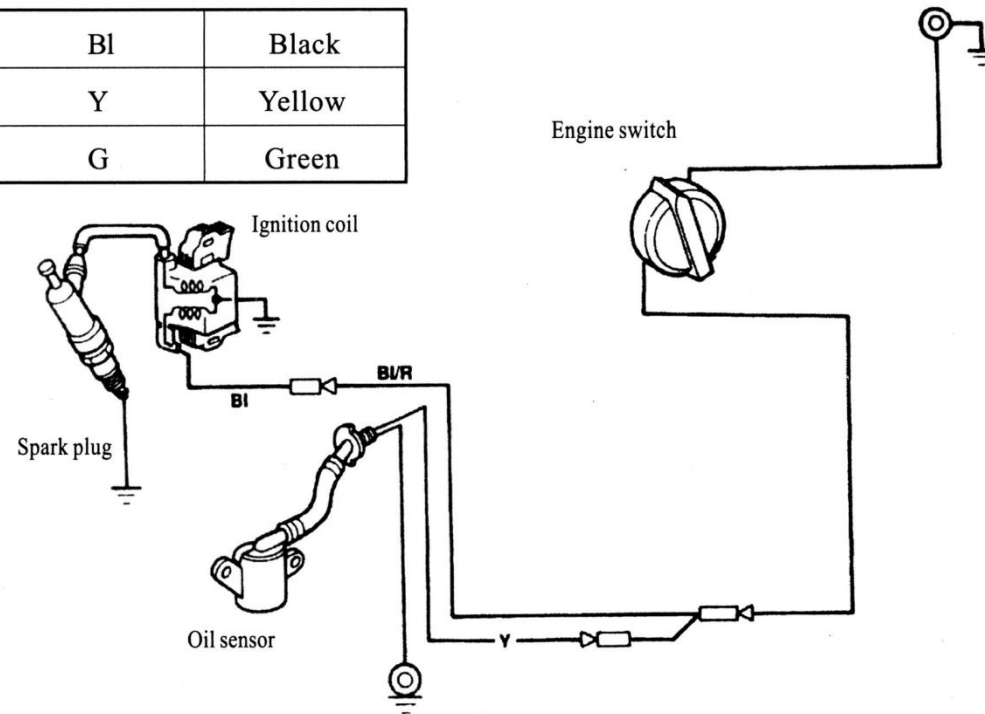

DuroMax Warranty:

DuroMax items (including, but not limited to generators, gas engines, and water pumps) carry a 1-year limited parts warranty. If, under the course of normal, non-commercial use, the DuroMax item fails within 1 year from the date of purchase, as a result of faulty materials or workmanship, Max Tool will provide necessary replacement or repair parts at no charge for the parts. Labor costs and shipping/handling costs are not included under this warranty policy and are the responsibility of the buyer. This warranty does not cover failure due to normal wear and tear or abuse. This warranty applies only to purchases made directly with Max Tool and only to the original purchaser. This warranty is void with misapplication, misuse, or negligence of the product.

DuroMax Power Equipment

5798 Ontario Mills Parkway
Ontario CA 91764

Phone Support: 800-629-3325 Option 4
M-F 7 am – 5 pm PST
Email Support: support@maxtool.com